

## TKS 300 C

### Description

The TKS range of roof fans have a square curb mounting and are easy to install.

The combination of a high quality external rotor motor and backward curved impeller ensures high performance and safe operation.

They are manufactured from polyester coated galvanised sheet metal for superior corrosion resistance. The speed controllable motors have sealed for life ball bearings.

TKS roof units have a swing out design for easy cleaning and maintenance.



### Technical data

Parameter	value	Unit
Voltage	230	V
Phase	1	~
Frequency	50	Hz
Power	71	W
Current	0,31	A
R.p.m.	2460	r.p.m.
Max. temperature of transported air	70	°C
Max. temperature of transported air when speed-controlled	70	°C
Sound pressure level at 3 m	60	dB(A)
Length	340	mm
Width	340	mm
Height	224	mm
Weight	4,3	kg
Enclosure class, motor	44	IP
Insulation class, motor	F	
Capacitor	2	µF

## Diagrams

○ Selected point

Flow [l/s]	<b>66,3</b>
Stat. pres. [Pa]	<b>221</b>
● Work point	
Flow [l/s]	<b>66,3</b>
Stat. pres. [Pa]	<b>221</b>
Power [W]	<b>69,9</b>
Current [A]	<b>0,306</b>
Speed [r.p.m.]	-
Efficiency [%]	<b>21</b>
SFP [kW/m <sup>3</sup> /s]	<b>1,03</b>
Voltage [V]	<b>230</b>

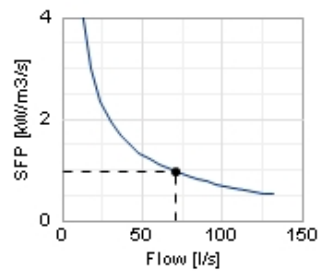
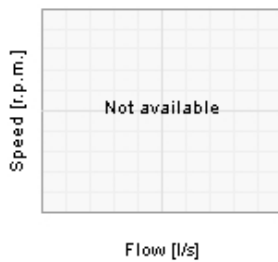
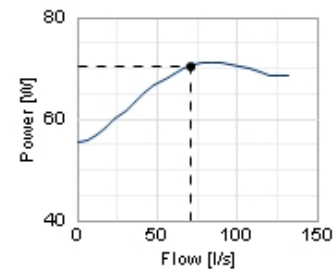
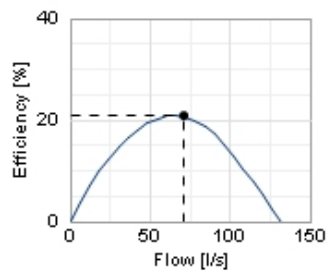
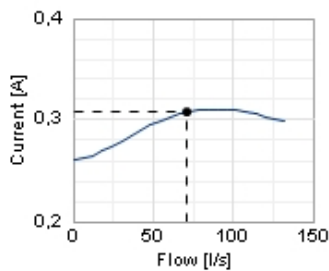
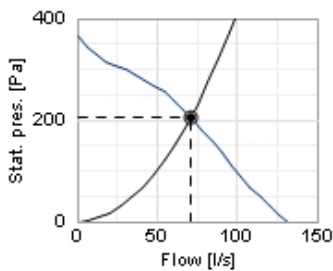

## Sound

○ Selected point

Flow [l/s]	<b>71</b>
Stat. pres. [Pa]	<b>206</b>
● Work point	
Flow [l/s]	<b>71</b>
Stat. pres. [Pa]	<b>206</b>
Total press. [Pa]	<b>213</b>
Power [W]	<b>70,4</b>
Current [A]	<b>0,308</b>
Speed [r.p.m.]	-
Efficiency [%]	<b>20,8</b>
SFP [kW/m <sup>3</sup> /s]	<b>0,974</b>
Voltage [V]	<b>230</b>

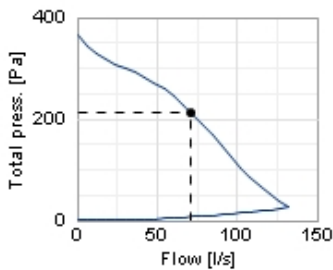
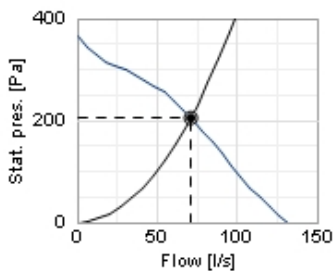

Distance: 3

Propagation type: Semi-spherical

Equivalent absorption area: 20

	Tot	63	125	250	500	1k	2k	4k	8k
Inlet Lw dB(A)	65	45	53	60	59	58	57	49	38
Surrounding Lw dB(A)	67	47	40	54	58	64	62	54	45
Surrounding Lp dB(A)	60	40	33	48	51	57	55	47	38

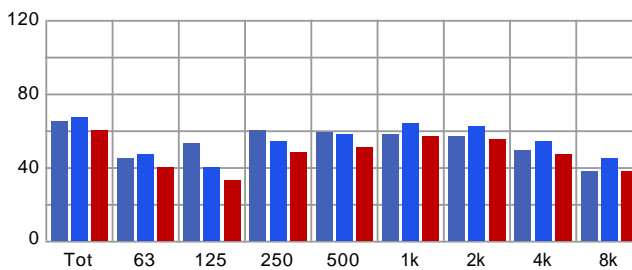

## Dimensions

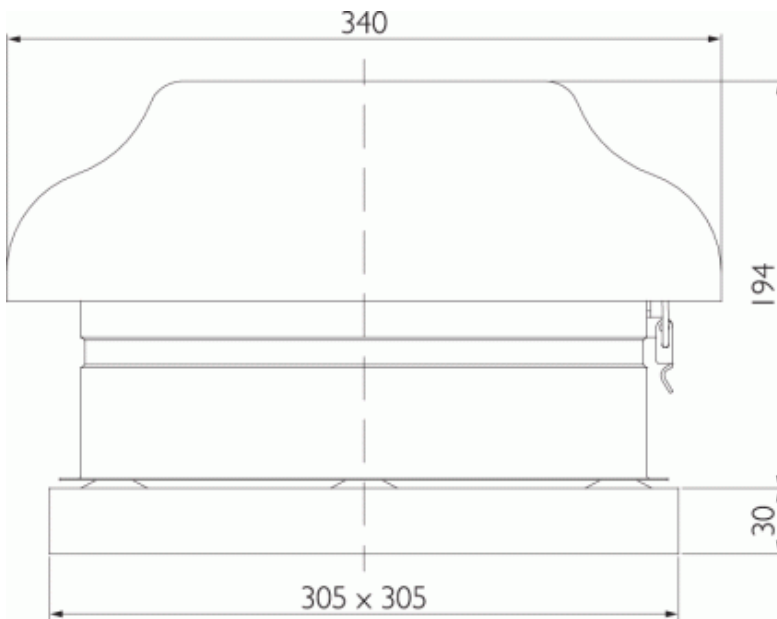

## INLOPPSDYSA / INLET CONE

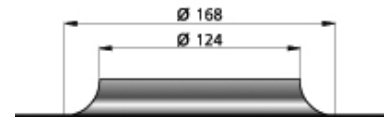

## Wiring diagram

4040001

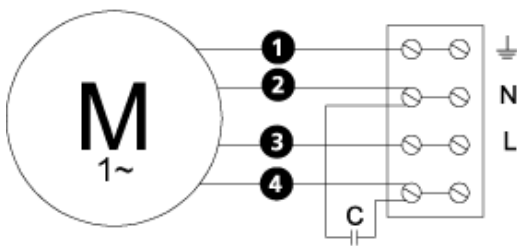

- (M) = Fan Motor
- (M1) = Fan Motor
- (M2) = Fan Motor
- (M3) = Rotor Motor
- 1 = Yellow/Green
- 2 = Black
- 3 = Blue
- 4 = Brown
- 5 = White (TW)
- 6 = Orange
- 7 = Grey
- 8 = Red
- 9 = Green
- 10 = Violet

## Accessories

### Electric accessories



VRDE 1,5



VRS 0,5



VRTEC

### Accessories



TFU 300